

**CONTROL
TECHNIQUES**

UNIDRIVE M400

ADVANCED CAPABILITY
LOW VOLTAGE AC DRIVES



0.25 kW - 132 kW (0.33 hp - 200 hp)
100 V | 200 V | 400 V | 575 V | 690 V

Fast set-up, diagnostics
with real-text display,
integrated PLC and
safety inputs

Nidec

All for dreams

E: sales@e-vfd.com | W: www.ct-nidec.com | T: (86-532)58-292-858

Unidrive M

Optimized throughput, open automation systems, maximum ease of use

Led by the results of extensive customer-driven market research, we have tailored five Unidrive M feature-sets to specific application needs identified within industrial automation.



All-round member of the Unidrive M family

Unidrive M400 is exceptional at combining the ease of use of our general purpose range with the capabilities of our high performance Unidrive M Series. The removable keypad with a real-text display makes it ideal for users who require extra diagnostic help when setting up parameters. Add in an impressive I/O count, dual Safe Torque Off (STO) and integrated PLC, all of which contribute to making Unidrive M400 an extremely capable drive.



Optional AI-485 Adaptors for RS485 communications

Optional AI-Back-up Adaptor allows the drive to use an SD card for parameter cloning and acts as an input for 24 V back-up. Optional AI- Smart Adaptor has built-in memory for parameter cloning and 24 V backup

Optional CI-Keypad - intuitive plain text multilingual back-lit LCD keypad for rapid set-up and superior diagnostics

Optional IP66 (NEMA 4) Remote Keypad available for flexible mounting

Power-on / drive status LED



Dual onboard Safe Torque Off (STO) terminals for easy SIL3 conformity

Conventional surface and DIN rail mounting (DIN rail mounting available on size 1 and 2 only)***

Drive rated to IP21 / UL open class (NEMA 1) on size 1 to 4 as standard

Conduit kits are available to meet UL Type 1 rating

User-friendly control connections

Easy-to-disconnect internal EMC filter*

User-friendly power connections*

Easy-to-remove terminal cover with tool-less close system (patent pending)

Robust cable management system providing grounding point for shielded control and power cables

Typical System Integration (SI) option module**

System Integration (SI) module slot for optional communications and additional I/O**

*Features and their locations vary on some drive sizes

** Frame 2 upwards

***Additional fixings recommended where heavy vibration is expected

Unidrive M400

Fast set-up and diagnostics with plain text display, integrated PLC and safety inputs

Unidrive M400 minimizes downtime with an intuitive LCD keypad offering a real-text, multi-language display for rapid set-up and clear diagnostic help. The integrated PLC can execute a substantial range of sequencing and logic programs. Coupled with an impressive I/O count complete with two STO inputs and an SI interface for a fieldbus option or extended I/O, this feature set ensures Unidrive M400's flexible integration with any system.

Minimize downtime and system set-up time with advanced keypad options

- Informative, multi-language, 3 line display aids set up and provides diagnostic information
- 4 navigation buttons facilitate intuitive navigation and programming
- Keypad options available:
 - CI-Keypad - drive mounted LCD keypad
 - Remote IP66 Keypad - rapid panel mount (1 x 32mm Ø hole)
 - No keypad - programming and control can be achieved via AI-485, CI-485 or fieldbuses such as SI-Profibus

Reduce system costs by directly integrating with applications

- Unidrive M400 incorporates an onboard PLC which can execute Machine Control Studio (IEC61131-3) programs for logic and sequencing with real-time tasks - removing the need for additional PLCs
- Fit an SI module to add fieldbus communications or additional I/O



Conform to safety standards, maximize uptime and reduce costs by integrating directly with safety systems

- Unidrive M400 has integrated dual STO inputs for SIL3 / PLe conformity, eliminating the need for external components

- Square law V/F mode is optimized for quadratic loads like pumps and fans to keep motor losses to a minimum
- Dynamic V to F mode keeps energy usage and motor losses to a minimum in low load conditions
- Unidrive M400 is highly efficient (above 98 %)

Energy saving

With energy costs a key factor in many industries, Unidrive M400 is packed with features to enhance energy efficiency:

- Low power standby mode for applications where drives can sit idle for significant periods
- Automatic 3-speed cooling fan keeps energy usage and acoustic noise to a minimum by intelligently responding to load and environmental conditions*

*From 0.37 kW

Machine Control Studio software

Unidrive M400's onboard PLC is programmed using Machine Control Studio which provides a flexible and intuitive environment for programming.

IEC 61131-3 automation programming

The programming environment is fully IEC 61131-3 compliant and therefore familiar, fast and easy to use for control engineers around the world.

The following IEC 61131-3 programming languages are supported:

- Structured Text (ST)
- Function Block Diagram (FBD)
- Structured Function Chart (SFC)
- Ladder Diagram (LD)
- Instruction List (IL)

Also supported:

- Continuous Function Chart (CFC)

Intuitive IntelliSense functionality helps to write consistent and robust programs, speeding up software development.

Programmers have access to a vibrant open-source community for function blocks. Machine Control Studio also supports customers' own function block libraries, with on-line monitoring of program variables with user defined watch windows and help for on-line change of programs, in line with latest PLC practices.

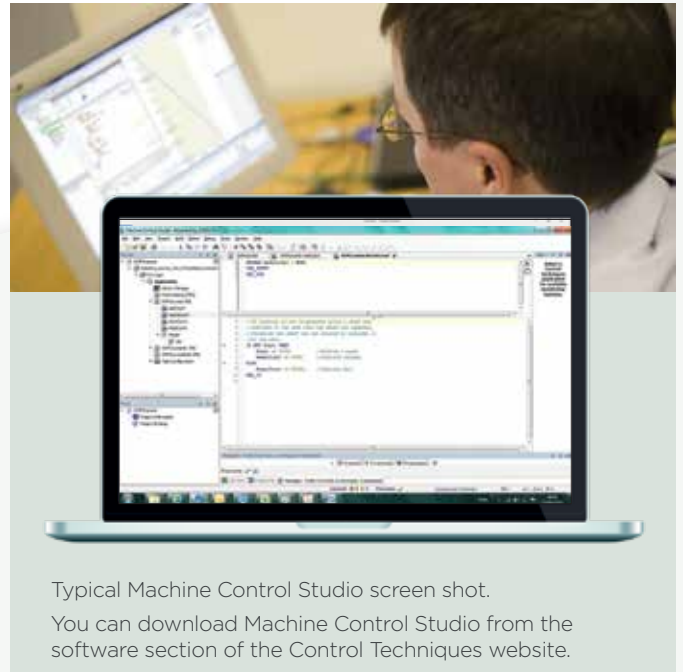

Typical Machine Control Studio screen shot.

You can download Machine Control Studio from the software section of the Control Techniques website.

Fast and easy access for commissioning, monitoring and diagnostics

Unidrive M Connect commissioning tool

The Connect PC tool is for commissioning, optimizing and monitoring drive/system performance.

Its development draws from extensive user research, using human centered design principles to give the ultimate user experience:

- Task-based drive operations are simplified with intuitive graphical tools in a familiar Windows environment
- Dynamic drive logic diagrams and enhanced searchable listings
- Drive and motor performance can be optimized with minimal specialized drive knowledge

- Tool is scalable to match application requirements
- Supports the import of Commander SK parameter files
- Drive discovery gives the ability to find drives on a network automatically without the user having to specify their addresses

Portable SD memory card

Standard SD cards can be used for quick and easy parameter and program storage using an adaptor. SD cards provide a huge memory capability allowing a system reload if required, and can be easily preprogrammed on a common PC.



Performance motor control

Unidrive M400 combines the latest microprocessor technology with unique motor control algorithms to give maximum stability of induction motors at all powers. Current loop update rates up to 125 μ s and complementary intelligent control features ensure that machine throughput and energy efficiency are maximized in all industrial applications.

Control Mode	Features
Enhanced open loop Rotor Flux Control for induction motors (RFC-A)	High performance speed and torque control through an advanced vector algorithm, utilizing closed loop current control to greatly enhance performance for all induction motor sizes without the need for a feedback device
Open loop vector or V/Hz induction motor control	Reliable performance and easy configuration: <ul style="list-style-type: none"> - 100 % torque available down to 1 Hz - Slip compensation - Square law V/F mode - Dynamic V/F mode - Multi-motor control

Easy motor pairing

Several intuitive tools are available to guarantee fast and optimized pairing between Unidrive M400 and AC induction motors. These include:

- Easy-to-use keypad with parameter reference guide on front panel
- Multilingual LCD remote keypad with clear parameter and diagnostic descriptions
- Three autotune procedures (stationary, rotating and inertia) to automatically optimize motor and drive configuration
- Connect commissioning software tool provides a comprehensive motor database and set up wizard



Unidrive M400 option choices and terminal layout

Control Mode









1. Open loop vector or V/Hz induction motor control
2. Open loop Rotor Flux Control for induction motors (RFC-A)



Input Output

SI-I/O	Onboard
 <ul style="list-style-type: none"> 4 x Digital I/O 3 x Analog inputs (default) / digital inputs 1 x Digital input 2 x Relays 	 <ul style="list-style-type: none"> 4 x Analog I/O 7 x Digital I/O 2 x STO 1 x Relay <p>The onboard I/O supports thermister input, encoder input, frequency input and PWM or frequency output</p>

Communication

AI-485 24 V Adaptor 	AI-485 Adaptor 	SI-EtherCAT 	SI-PROFIBUS 	SI-Ethernet 
CI-485 Adaptor 	SI-DeviceNet 	SI-CANopen 	SI-PROFINET 	

DC back up power supply



AI-Back-up Adaptor and AI-Smart Adaptor (Input for 24 V back-up)





Optional Drive Programming and Operator Interface

Connect Commissioning Software



FREE Software

Remote Keypad (LCD)



CI-keypad



Remote keypad RTC



AI-Back-up Adaptor
(provides SD card usage for programming / cloning)



AI-Smart Adaptor
(built in memory for programming / cloning)



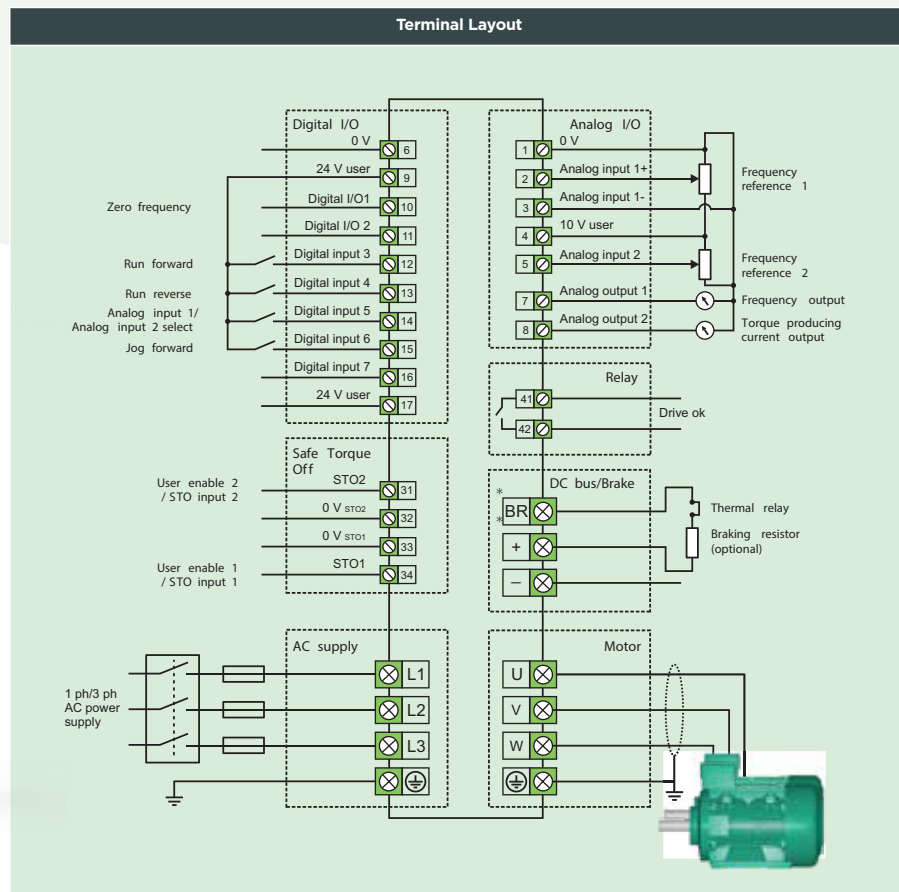

* For frame sizes 5 - 9 STO input, refer to Unidrive M400 documentation

Unidrive M400 ratings and specifications

100/120 Vac ±10 %							
Order Code	Supply Phases	Heavy Duty			Normal Duty		
		Max Continuous Current (A)	Motor Shaft Power (kW)	Motor Shaft Power (hp)	Max Continuous Current (A)	Motor Shaft Power (kW)	Motor Shaft Power (hp)
M400-011 00017A	1	1.7	0.25	0.33	For Normal Duty applications, use Heavy Duty ratings.		
M400-011 00024A	1	2.4	0.37	0.5			
M400-021 00042A	1	4.2	0.75	1			
M400-021 00056A	1	5.6	1.1	1.5			

200/240 Vac ±10 %							
Order Code	Supply Phases	Heavy Duty			Normal Duty		
		Max Continuous Current (A)	Motor Shaft Power (kW)	Motor Shaft Power (hp)	Max Continuous Current (A)	Motor Shaft Power (kW)	Motor Shaft Power (hp)
M400-012 00017A	1	1.7	0.25	0.33	For Normal Duty applications, use Heavy Duty ratings.		
M400-012 00024A	1	2.4	0.37	0.5			
M400-012 00033A	1	3.3	0.55	0.75			
M400-012 00042A	1	4.2	0.75	1			
M400-022 00024A	1/3	2.4	0.37	0.5			
M400-022 00033A	1/3	3.3	0.55	0.75			
M400-022 00042A	1/3	4.2	0.75	1			
M400-022 00056A	1/3	5.6	1.1	1.5			
M400-022 00075A	1/3	7.5	1.5	2			
M400-032 00100A	1/3	10	2.2	3			
M400-042 00133A	1/3	13.3	3	3			
M400-042 00176A	3	17.6	4	5			
M400-052 00250A	3	25	5.5	7.5	30	7.5	10
M400-062 00330A	3	33	7.5	10	50	11	15
M400-062 00440A	3	44	11	15	58	15	20
M400-072 00610A	3	61	15	20	75	18.5	25
M400-072 00750A	3	75	18.5	25	94	22	30
M400-072 00830A	3	83	22	30	117	30	40
M400-082 01160A	3	116	30	40	149	37	50
M400-082 01320A	3	132	37	50	180	45	60
M400-092 01760A	3	176	45	60	216	55	75
M400-092 02190A	3	219	55	75	266	75	100

380/480 Vac ±10 %							
Order Code	Supply Phases	Heavy Duty			Normal Duty		
		Max Continuous Current (A)	Motor Shaft Power (kW)	Motor Shaft Power (hp)	Max Continuous Current (A)	Motor Shaft Power (kW)	Motor Shaft Power (hp)
M400-024 00013A	3	1.3	0.37	0.5	For Normal Duty applications, use Heavy Duty ratings.		
M400-024 00018A	3	1.8	0.55	0.75			
M400-024 00023A	3	2.3	0.75	1			
M400-024 00032A	3	3.2	1.1	1.5			
M400-024 00041A	3	4.1	1.5	2			
M400-034 00056A	3	5.6	2.2	3			
M400-034 00073A	3	7.3	3	3			
M400-034 00094A	3	9.4	4	5			
M400-044 00135A	3	13.5	5.5	7.5			
M400-044 00170A	3	17	7.5	10			
M400-054 00270A	3	27	11	20	30	15	20
M400-054 00300A	3	30	15	20	30	15	20
M400-064 00350A	3	35	15	25	38	18.5	25

M400-064 00420A	3	42	18.5	30	48	22	30
M400-064 00470A	3	47	22	30	63	30	40
M400-074 00660A	3	66	30	50	79	37	50
M400-074 00770A	3	77	37	60	94	45	60
M400-074 01000A	3	100	45	75	112	55	75
M400-084 01340A	3	134	55	100	155	75	100
M400-084 01570A	3	157	75	125	184	90	125
M400-094 02000A	3	200	90	150	221	110	150
M400-094 02240A	3	224	110	150	266	132	200

500/575 Vac ±10 %							
Drive	Supply Phases	Heavy Duty			Normal Duty		
		Max Continuous Current (A)	Typical Output (kW)	Motor Power (hp)	Max Continuous Current (A)	Typical Output (kW)	Motor Power (hp)
M400-055 00030 A	3	3	1.5	2	3.9	2.2	3
M400-055 00040 A	3	4	2.2	3	6.1	4	5
M400-055 00069 A	3	6.9	4	5	10	5.5	7.5
M400-065 00100 A	3	10	5.5	7.5	12	7.5	10
M400-065 00150 A	3	15	7.5	10	17	11	15
M400-065 00190 A	3	19	11	15	22	15	20
M400-065 00230 A	3	23	15	20	27	18.5	25
M400-065 00290 A	3	29	18.5	25	34	22	30
M400-065 00350 A	3	35	22	30	43	30	40
M400-075 00440 A	3	44	30	40	53	37	50
M400-075 00550 A	3	55	37	50	73	45	60
M400-085 00630 A	3	63	45	60	86	55	75
M400-085 00860 A	3	86	55	75	108	75	100
M400-095 01040 A	3	104	75	100	125	90	125
M400-095 01310 A	3	131	90	125	150	110	150

500/690 Vac ±10 %							
Drive	Supply Phases	Heavy Duty			Normal Duty		
		Max Continuous Current (A)	Typical Output (kW)	Motor Power (hp)	Max Continuous Current (A)	Typical Output (kW)	Motor Power (hp)
M400-076 00190 A	3	19	15	20	23	18.5	25
M400-076 00240 A	3	24	18.5	25	30	22	30
M400-076 00290 A	3	29	22	30	36	30	40
M400-076 00380 A	3	38	30	40	46	37	50
M400-076 00440 A	3	44	37	50	52	45	60
M400-076 00540 A	3	54	45	60	73	55	75
M400-086 00630 A	3	63	55	75	86	75	100
M400-086 00860 A	3	86	75	100	108	90	125
M400-096 01040 A	3	104	90	125	125	110	150
M400-096 01310 A	3	131	110	150	150	132	175

Key:

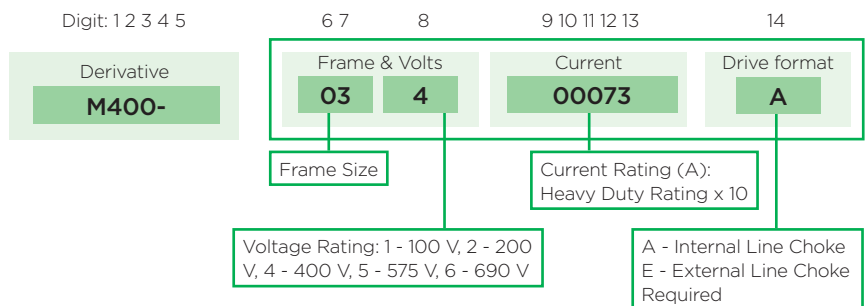

See overleaf for Normal Duty and Heavy Duty definitions.

Unidrive M400 ratings and specifications

Environmental safety and electrical conformance

Size 1 to 4:

- IP21 / UL open class (NEMA 1). IP20 when the AI-Back-up or AI-485 Adaptors are fitted. UL TYPE 1 compliance requires the appropriate conduit kit to be fitted.
- Ambient temperature -20 °C (4 °F) to 40 °C (104 °F) as standard. 60 °C/ 140 °F with derating for frames 1-4.

Size 5 to 9:

- IP20 / UL open class (NEMA 1). UL TYPE 1 compliance requires the appropriate conduit kit to be fitted. IP65 / UL TYPE 12 rating is achieved on the rear of the drive when through panel mounted.
- Ambient temperature -20 °C (4 °F) to 40 °C (104 °F) as standard. 55°C/ 131 °F with derating for frames 5-9.
- Storage temperature -40 °C to 60 °C (-40 °F to 140 °F).
- Humidity 95 % maximum (non-condensing) at 40 °C (104 °F) in accordance with EN/IEC 60068-2-78 and ANSI/EIA-364-31.

- EN/IEC 60068-2-60, Method 4 Corrosive gas.
- Altitude: 0 to 3000 m (0 to 9843 ft), derate 1 % per 100 m (328 ft) between 1000 m and 3000 m (3281 ft and 9843 ft).
- Random Vibration: Tested in accordance with EN/IEC 60068-2-64 with SI and AI option modules fitted.
- Mechanical Shock: Tested in accordance with EN/IEC 60068-2-29.
- Electromagnetic Immunity complies with EN/IEC 61800-3 and EN/IEC 61000-6-2.
- With onboard EMC filter, complies with EN/IEC 61800-3 (2nd environment).
- EN/IEC 61000-6-3 and EN/IEC 61000-6-4 with optional footprint EMC filter.
- EN/IEC 61800-5-1 Electrical Safety.
- EN/IEC 61131-2 I/O.
- Safe Torque Off, independently assessed by TÜV to EN/IEC 61800-5-2 SIL3 and EN ISO 13849-1 PLe.
- UL 508C Electrical Safety.

Unidrive M400 features and specification table

	Current loop update: 125 µs
Performance	Heavy Duty peak rating: 180 % (3 s), 150 % (60 s)
	Maximum output frequency: 550 Hz
	Switching frequency range: 0.67, 1, 2, 3, 4, 6, 8, 12, 16 kHz (3 kHz default)
Onboard intelligence	Programmable Logic Control (PLC) - memory: 16 kB
	1 x Real-time task (16ms), 1 x Background task
Mechanical attributes	DIN rail mountable (size 1 and 2)
	Commander SK compatible mechanical footprint either as standard or with conversion plates
Parameter back-up	Serial port cloning (using optional AI-485 Adaptor or CI-485 Adaptor)
	SD card (using optional AI-Back-up Adaptor)
Follower	Encoder Input 1
Onboard I/O	2 x Analog inputs, 2 x Analog outputs
	5 x Digital inputs, 2 x Bidirectional digital inputs or outputs
	1 x Relay output
Machine safety	2 x Safe Torque Off (STO) inputs
Back-up power	24 V control back-up (using optional AI-Back-up Adaptor) AI-Smart Adaptor (Built-in memory for parameter cloning and 24 V backup)
	Temperature controlled fan with standby (off)
Other	User replaceable fan(s)
	Conformal coating
	Standby mode (energy saving)
	User defined security levels (e.g. restricted access or read-only parameters via user defined security code)

Unidrive M operating modes

Operating mode	RFC from cold	RFC from 100 %	Open loop from cold	Open loop from 100 %
Normal duty overload with motor rated current = drive rated current	110 % for 165 s	110 % for 9 s	110 % for 165 s	110 % for 9 s
Heavy duty overload with motor rated current = drive rated current (size 8 and below)	180 % for 3 s	180 % for 3 s	150 % for 60 s	150 % for 8 s
Heavy duty overload with motor rated current = drive rated current (size 9)	175 % for 42 s	175 % for 5 s	150 % for 60 s	150 % for 7 s

Dimensions and Weight



Frame Size		1	2	3	4	5	6	7	8	9A	9E
Dimensions (H x W x D)	mm	160 x 75 x 130	205 x 78 x 150	226 x 90 x 160	277 x 115 x 175	365 x 143 x 202	365 x 210 x 227	508 x 270 x 280	753 x 310 x 290	1049 x 310 x 290	1010 x 310 x 290
	in	6.3 x 3.0 x 5.1	8.1 x 3.1 x 5.9	8.9 x 3.5 x 6.3	10.9 x 4.5 x 6.9	14.4 x 5.6 x 8	14.4 x 8.3 x 8.9	20 x 10.6 x 11.0	29.6 x 12.2 x 11.4	41.3 x 12.2 x 11.4	39.7 x 12.2 x 11.4
Weight	kg (lb)	0.75 (1.65)	1.0 (2.2)	1.5 (3.3)	3.13 (6.9)	7.4 (16.3)	14 (30.9)	28 (61.7)	50 (110.2)	66.5 (146.6)	46 (101.4)

Notes:

From frame sizes 5 onwards dimensions do not include removable mounting brackets. Additional distance should be added to the height dimension (H) when the following options are fitted:

- AI-Back-up Adaptor: 15 mm (0.59 in)
- AI-485 Adaptor: 26 mm (1.02 in)
- AI-Smart Adaptor: 15 mm (0.59 in)

Optional keypad

Description/Order code	Order code
Remote Keypad	82500000000001
CI-keypad	825000000000000
Remote keypad RTC	82400000019600

Optional accessories

Description/Order code	Order code
AI-Back-up Adaptor	825000000000004
AI-485 Adaptor	825000000000003
AI-Smart Adaptor	82500000018500
CI-485 Adaptor	825000000000002

Through hole kits

IP65 / UL TYPE 12 rating is achieved on the rear of the drive when through panel mounted using the following kits.

Frame size	Order code
5	3470-0067
6	3470-0055
7	3470-0079
8	3470-0083

IP55 / UL TYPE 12 rating can be achieved for frame sizes 9A and 9E using the following kits:

Frame size	Order code
9A	3470-0119
9E	3470-0105

UL Type 1 Conduit kit

Frame size	Order code
1	3470-0091
2	3470-0094
3	3470-0098
4	3470-0102
5	3470-0069
6	3470-0059
7	3470-0080
8 / 9A	3470-0088
9E	3470-0115

Retrofit mounting brackets

These mounting brackets ensure the drive can be mounted on existing Commander SK installations.

Frame size	Order code
3	3470-0097
4	3470-0101
5	3470-0066
6	3470-0074
7	3470-0078
8	3470-0087
9A / 9E	3470-0118

Line reactor

Frame size	Order code
9E (200 V/400 V)	4401-0181
9E (575 V/600 V)	4401-0183

Finger-guard grommet

Frame size	Order code
9A / 9E	3470-0107

Lifting tool

Frame size	Order code
9A	7778-0045
9E	7778-0016

Fan replacement kit

Frame size	Order code
1	3470-0092
2	3470-0095
3	3470-0099
4	3470-0103

Optional external EMC filters

Unidrive M built-in EMC filter complies with EN/IEC 61800-3. External EMC filters are required for compliance with EN/IEC 61000-6-4 as per the table below.

Frame size	Voltage	Phases	Type	Order code
1	All	1	Standard	4200-1000
			Low leakage	4200-1001
2	100 V	1	Standard	4200-2000
			Standard	4200-2001
			Low leakage	4200-2002
	200 V	1	Standard	4200-2003
			Low leakage	4200-2004
			Standard	4200-2005
400 V	3	Standard	4200-2006	
		Standard	4200-3000	
		Low leakage	4200-3001	
3	200 V	3	Standard	4200-3004
			Low leakage	4200-3005
			Standard	4200-3008
	400 V	3	Low leakage	4200-3009
			Standard	4200-4000
			Low leakage	4200-4001
4	200 V	3	Standard	4200-4002
			Low leakage	4200-4003
			Standard	4200-4004
	400 V	3	Low leakage	4200-4005
			Standard	4200-0312
			Standard	4200-0402
5	400 V	3	Standard	4200-0122
			Standard	4200-2300
			Standard	4200-4800
6	575 V	3	Standard	4200-3690
			Standard	4200-1132
			Standard	4200-0672
7	200 V & 400 V	3	Standard	4200-0672
			Standard	4200-1972
			Standard	4200-1662
8	200 V & 400 V	3	Standard	4200-1972
			Standard	4200-1662
			Standard	4200-1662
9A	575 V & 690 V	3	Standard	4200-3021
			Standard	4200-1660
			Standard	4200-1660
9E	200 V & 400 V	3	Standard	4200-4460
			Standard	4200-4460
			Standard	4200-2210

For a full list of patents and patent applications, visit www.controltechniques.com/patents.



Nidec

All for dreams

#1 for advanced motor and drive technology

Nidec Corporation is a global manufacturer of electric motors and drives. Founded in 1973, Nidec has worldwide operations and a workforce of more than 110,000 who develop, manufacture and install motors, drives and control systems in industrial plants, automobiles, home appliances, office equipment and information technology.



110,000
EMPLOYEES
WORLDWIDE



\$11B
GROUP
TURNOVER



70+
COUNTRIES



230+
COMPANIES

CONTROL™ TECHNIQUES

DRIVE SPECIALISTS SINCE 1973

Drives: they're what we do. Whether you're designing a new machine or installing a replacement, we know you need quick delivery and an easy set up, with the confidence that your drive's going to keep on performing with accurate control.

So leave it to the specialists. We've dedicated ourselves to designing and manufacturing variable speed drives since 1973. This means quick set up, high reliability, maximum motor control and fast, efficient service.



1,000+
OEM
CUSTOMERS



5M+
INSTALLED
DRIVES



1,000+
EMPLOYEES
WORLDWIDE



70
COUNTRIES



Outstanding performance

The outstanding performance of our drives is the fruit of over 45 years of engineering experience in drive design.



Technology you can rely on

Robust design and the highest build quality ensure the enduring reliability of the millions of drives installed around the world.

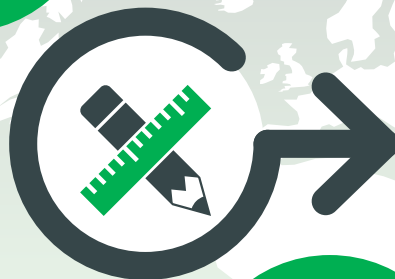

Open design architecture

Based on open design architecture, our drives integrate with all primary communication protocols.



Embedded intelligence

Precision motor control is combined with the highest embedded intelligence, ensuring maximum productivity and efficiency of your machinery.

Global reach, local support

Highly experienced, locally based Application Engineers design and support drive technology to provide maximum value, wherever you are in the world.

A part of the Nidec Group

Connect with us at:



www.controltechniques.com

Control Techniques is your global drives specialist.

With operations in over 70 countries, we're open for business wherever you are in the world.

For more information, or to find your local drive centre representatives, visit

www.controltechniques.com



© 2018 Nidec Control Techniques Limited. The information contained in this brochure is for guidance only and does not form part of any contract. The accuracy cannot be guaranteed as Nidec Control Techniques Ltd have an ongoing process of development and reserve the right to change the specification of their products without notice.

Nidec Control Techniques Limited. Registered Office: The Gro, Newtown, Powys SY16 3BE. Registered in England and Wales. Company Reg. No. 01236886.

P.N. 0778-0040-09 05/19

E: sales@e-vfd.com | W: www.ct-nidec.com | T: (86-532)58-292-858